



# Qualification and Implementation of Laser Shock Peening on F-35 & Lessons Learned

**LOCKHEED MARTIN**

**CURTISS -  
WRIGHT**



**HILL  
ENGINEERING**  
Predict. Test. Perform.



analytical processes / engineered solutions

Presented by – Scott Carlson  
Scott.Carlson@lmco.com  
*Lockheed Martin Aeronautics  
F-35 Service Life Analysis Group  
Fatigue and Crack Growth Methods Lead  
Co-Authors Listed Later in Presentation*

# Agenda for Presentation

- Epistemology of F-35 Critical Locations and Reason for Application of Laser Shock Peening
- Development of Laser Shock Peening Strategy for F-35B 7085-T7452
  - Laser Shock Peening process development
- Use of Digital Engineering to Ensure Precise, Auditable Processing
- Lessons Learned from Application Development, Implementation within a Depot Environment
- Certification of Laser Shock Peening for F-35C on Ti-6Al-4V BA ELI
  - Overview of methods and results
  - Lessons learned and path forward

# History of Laser Shock Peening on F-35

- F-35B & C Full-Scale Durability Test (FSDT) Started - May 2010<sup>1</sup>

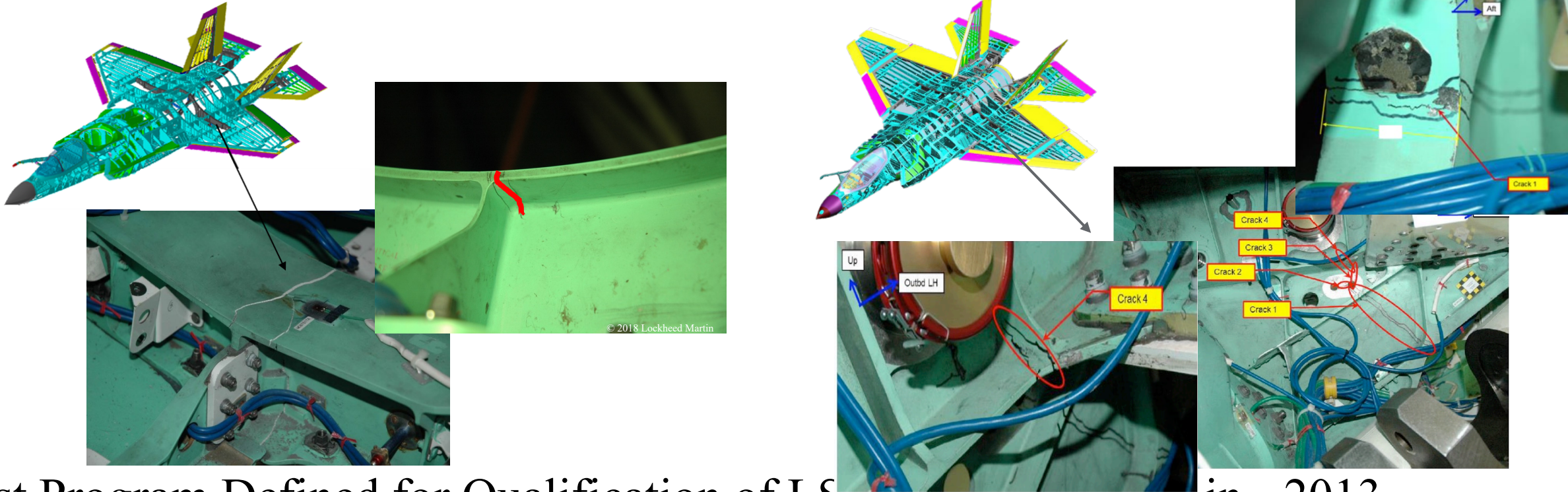

- Test Program Defined for Qualification of LSP for Life Benefit in - 2013
  - Development and application of Metal Improvement Company's (MIC) LSP process and methodology to enable life requirements<sup>2</sup>
  - F-35B has completed all certification requirements and F-35C has one more area to qualify

# Overview of Life Improvements

- LSP will be Applied to Approx. 170 Locations During Sustainment
  - Application will come during different phases of depot maintenance
- Over 250 Fatigue Tests Performed
- Almost 100 Tests to Quantify the Residual Stress State from LSP
  - Includes Element and Subcomponent tests and the determination of residual stresses in over 60 coupons
- LSP Demonstrated Consistent Life Improvement Factors for Fatigue and Crack Growth<sup>3,4</sup>
  - Great confidence in its application across the airframe to meet life limit requirements

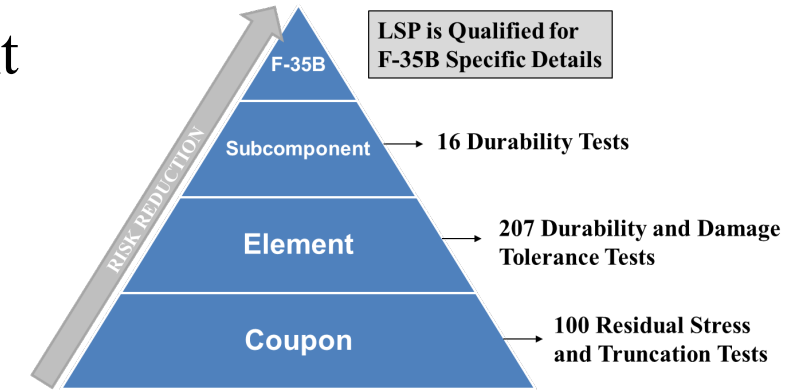

Coupon Identifier	Coupon Configurations	Beta from Weibull Analysis	N/95/Eta FMF
71005	Baseline	2.13	For LSP over EDM = <b>7.34</b> , For Blend+EDM+LSP = <b>1.85</b>
	5 LP Configs.	12.00 - 4.00	
71019	Baseline	3.54	For LSP over EDM = <b>3.81</b> , For Blend+EDM+LSP = <b>4.37</b>
	6 LP Configs.	17.46 - 4.00	
71020	Baseline	12.91	For LSP over EDM = <b>2.37</b> , for EDM over LSP = <b>5.09</b>
	2 LP Configs.	3.50 - 1.60	
71021	Baseline	33.03	For EDM+LSP+Anodize to Baseline EDM+Anodize = <b>7.22</b>
	2 LP Configs.	2.13 and No Failures	

Coupon Identifier	Coupon Configurations	Beta from Weibull Analysis	N/95/Eta FMF
91011	Baseline	25.00	For LSP over EDM to Baseline EDM+Anodize = <b>4.84</b> , for EDM over LSP to Baseline EDM+Anodize = <b>6.30</b>
	5 LP Configs.	7.55 - No Failures	
91015	Baseline	19.14	For EDM+LSP+Anodize to Baseline EDM+Anodize = <b>1.71</b> , for 3GW/cm <sup>2</sup> LSP+Anodize = <b>5.98</b>
	6 LP Configs.	97.25 - No Failures	
91017	Baseline	8.55	For EDM+LSP+Anodize to Baseline EDM+Anodize = <b>2.49</b> , for 4GW/cm <sup>2</sup> LSP+Anodize = <b>3.37</b>
	2 LP Configs.	9.77 - No Failures	
91018	Baseline	8.34	For EDM+LSP+Anodize to Baseline EDM+Anodize = <b>3.09</b> , for LSP+Anodize+EDM to Baseline = <b>3.59</b>
	4 LP Configs.	3.85 - No Failures	
91022	Baseline	5.41	For EDM+LSP+Anodize to Baseline EDM+Anodize (with Subcomponent added) = <b>4.20</b>
	4 LP Configs.	8.38 - No Failures	

# Laser Shock Peening Process Development by Metal Improvement Company for F-35B

# Complexity of F-35B Required Innovation

	F-22 on-aircraft Laser Peening Program	F-35B on-aircraft Laser Peening Program
Aircraft Process Cells	1	2
Process Robots per Cell	1	3
Process Views (Vantage Points)	26	167
Views Requiring Relay Mirror	None	68
Water Delivery	Fixed Nozzles	Water Robot
Pattern Registration	Manual Process	Automatic with Passive Alignment Targets
Software Controls	Hard Coded	Flexible Script-Driven

**Note: The F-22 program very successfully treated 52 aircraft!<sup>5-7</sup> Many aspects of that program’s equipment and controls have been overhauled and improved to support the F-35B & C program.**

# FRC-East Facility Overview with 2 Cells

- 2-Cell System Enables Concurrent Processing of 2 Aircraft
- Concurrent Work in Both Cells
  - Cleaning, inspection, taping, and robot positioning occurs in a cell
  - LSP applied in other cell
  - Interlocks ensure safety and efficiency of process
- Full Scale Test Article (BG-1) Utilized for LSP Process Deployment, Testing and Validation
  - At CWST laser facility (Livermore, Ca)
  - At FRC-East (Havelock, NC)

FRC-E F-35 Installation

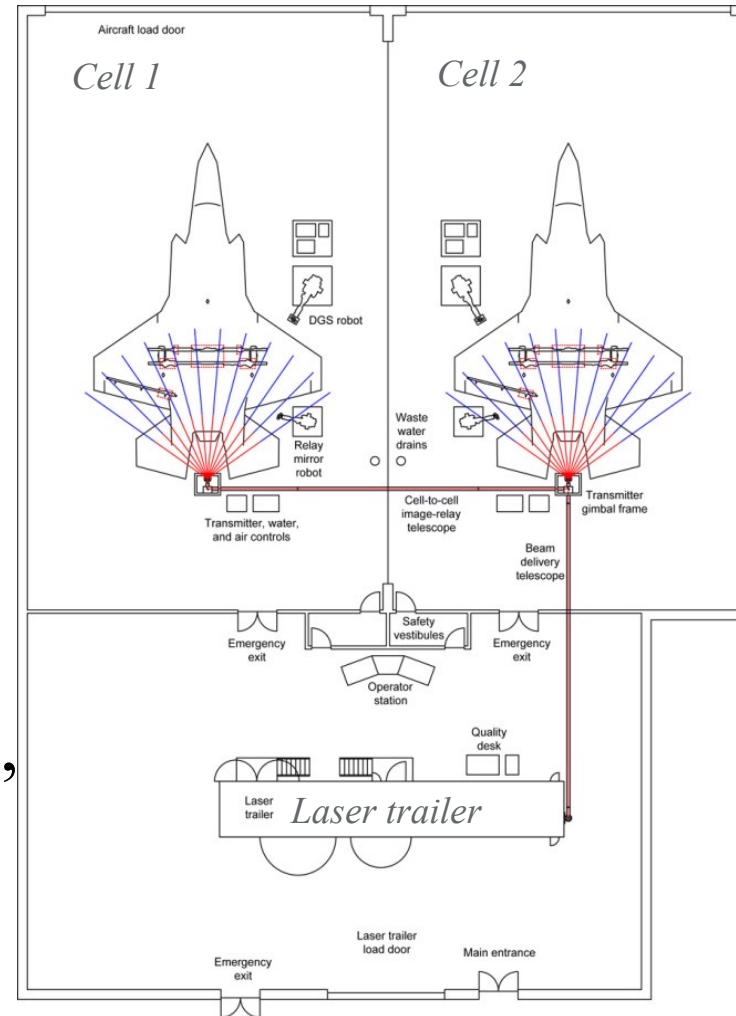

# BG-1 – Key to Successful Deployment

- Sectioning of BG-1 Performed by the Weapons Survivability Lab, China Lake NAS
- Delivered to MIC-Livermore in Late 2018
- Asset Mounted on a Surrogate Frame
  - Approximately represent jacking positions of the real airframe
- BG-1 was Invaluable for Development, Testing, and Demonstrating the System
- BG-1 is Key for Continuous Improvement
  - Development of LSP locations continues
- CG-1 Performing the Same Function for the F-35C Development

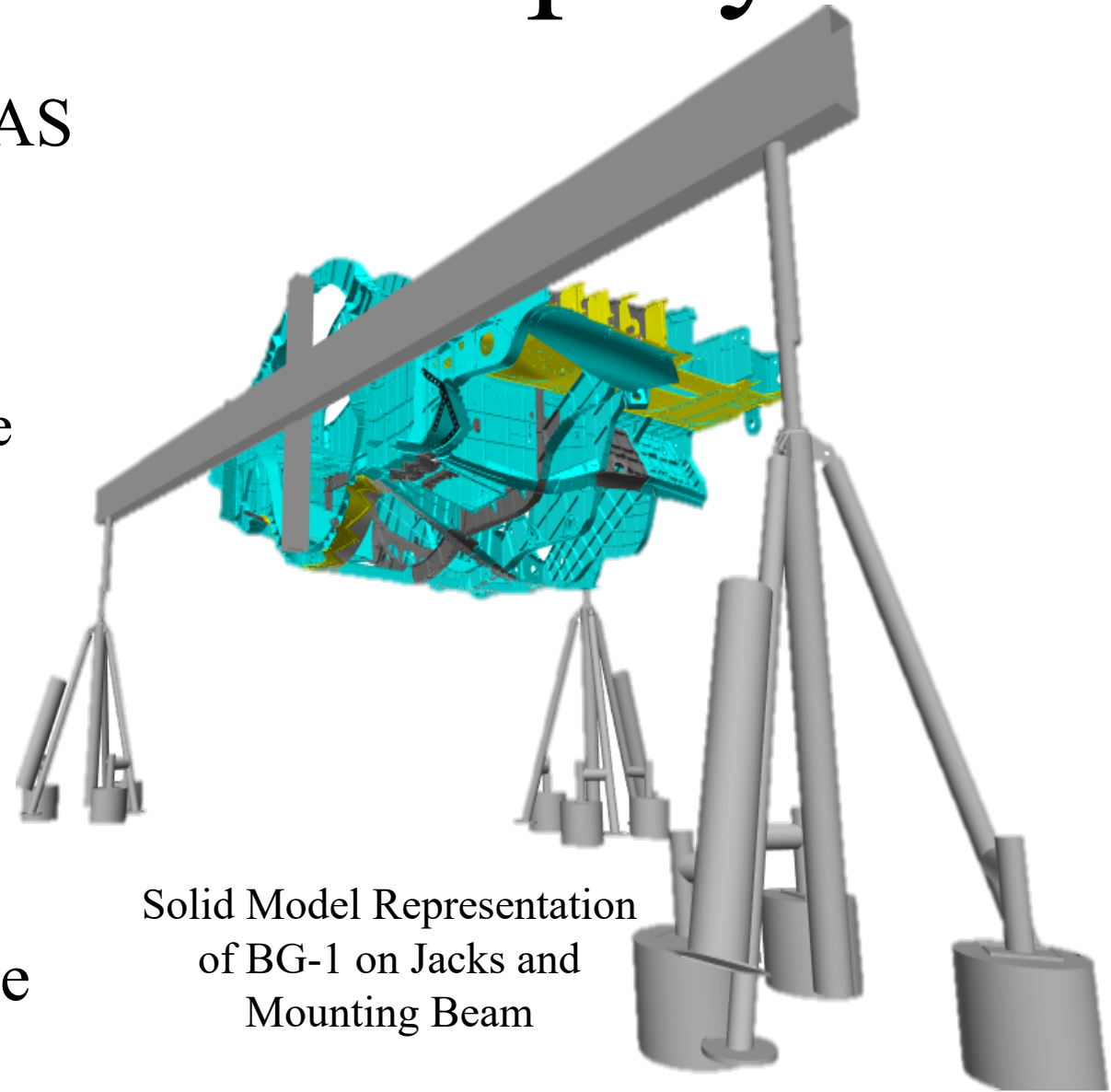

Solid Model Representation  
of BG-1 on Jacks and  
Mounting Beam



# 3 Robots Allow Flexibility to Apply LSP

Representation of Robot and Jack Positioning During LSP Application

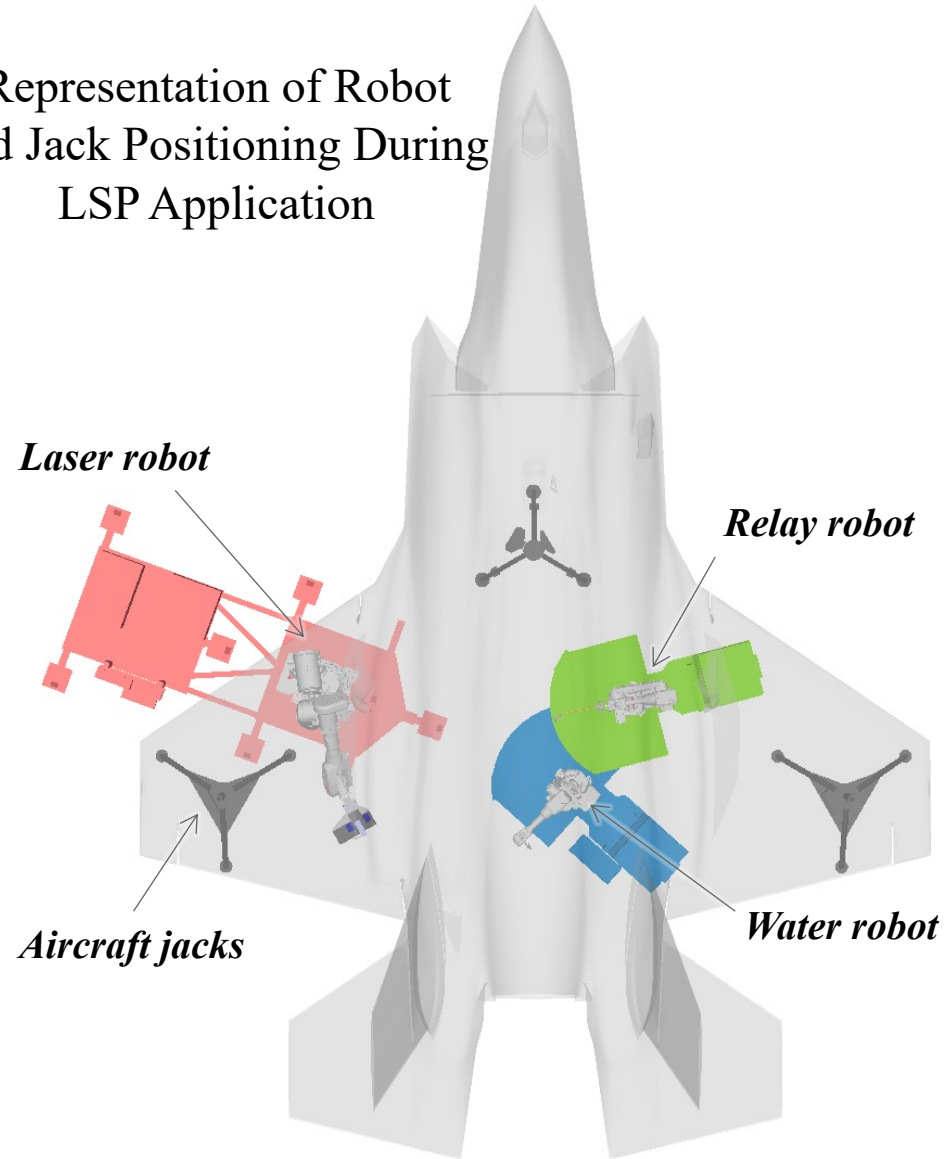

- Three Floating Robots can be Reconfigured as Needed Under and Around the Plane to Apply LSP
  - Laser delivery robot brings the beam from the transmitter to the plane
  - Water robot applies tamping water layer on a shot-by-shot basis
  - Relay robot provides line-of-sight to hidden areas

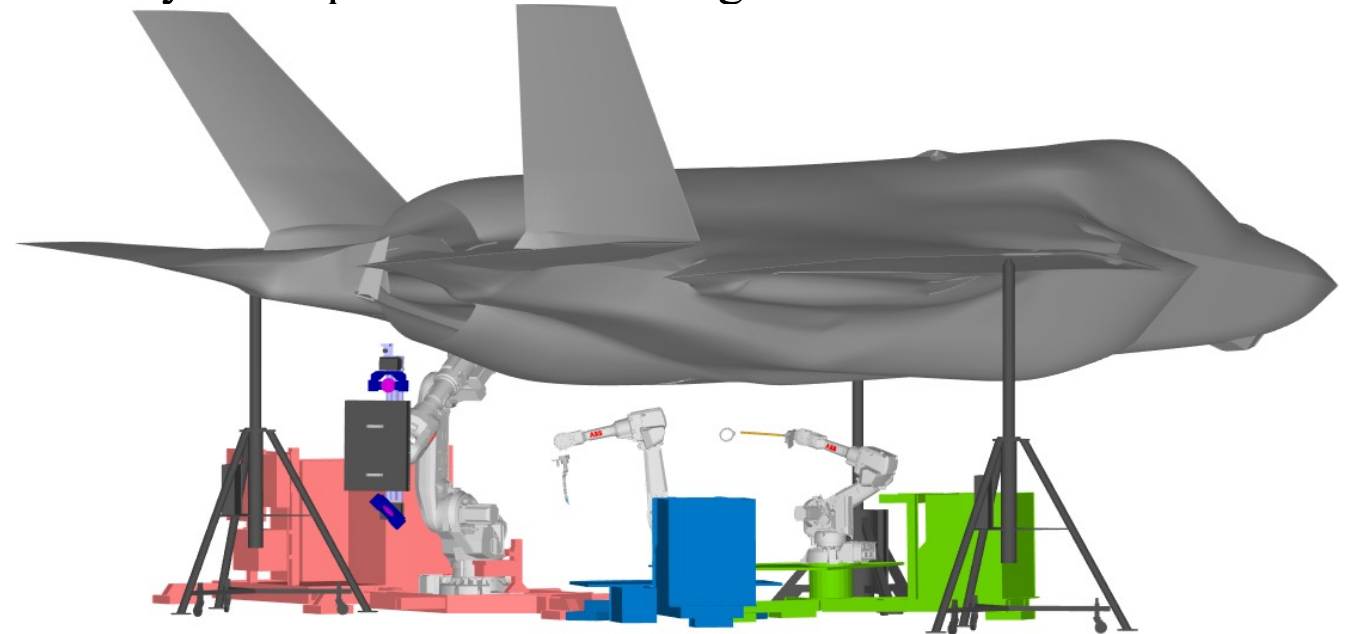

Solid Model Representation of Process Robots for LSP Application

# LSP Process is Designed Around the Digital Thread

- Patterns are Designed and Maintained on OEM CAD Files Using Original Aircraft Coordinates
- Script-based Control System Allows for Quick Customization
  - F-35B has multiple geometric configurations for same locations
  - Due to design changes during Low-Rate Initial Production (LRIP)
- Monitoring Tools Allow Users to Visualize Simulation of Robot Motion Before, During and After Processing
- Key Process Parameters on a Shot-by-Shot Basis are Digitally Stored, Used for Quality Assurance<sup>8,9</sup>
  - Integration into Digital Thread with validated residual stresses

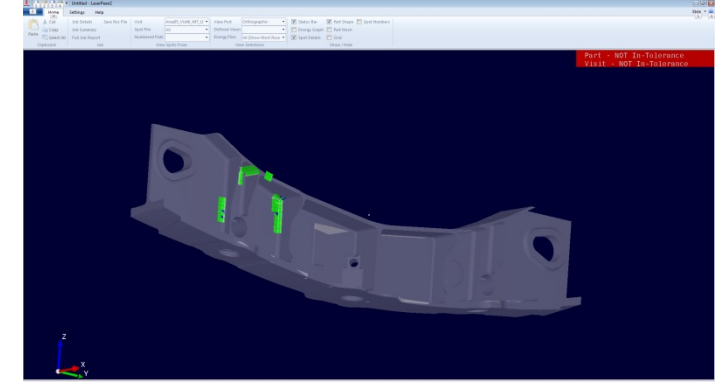
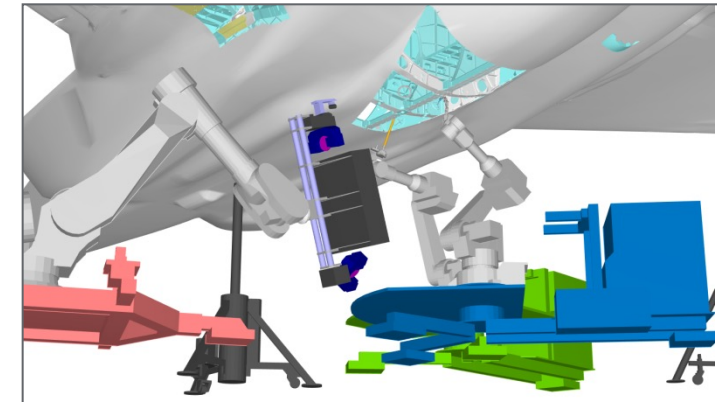

# Lessons Learned from Process Development

- Begin Planning Early when Integrating Laser Shock Peening
  - LSP is an **engineered** residual stress process – requires design for successful implementation
- Develop a Solid Plan for Implementation
  - Must have all stakeholders involved in decision making
  - Plan the **where, how, when, who**, and the **funding source** for the lifecycle of the process
  - Integrate the Depot Team as soon as possible to ensure proper implementation
    - For LSP buildings or shelters often need to be built for implementation – takes **time, planning** and **funding**
  - The importance of BG-1 and CG-1 cannot be over stated – it was a **MUST**
    - Allowed for early process planning, development, application, training, and testing all on a safe, realistic article
- Plan for Things to Go Wrong – We all know that it will happen
- Develop a Digital Data Capture Plan – Digital Engineering is the Wave of the Future<sup>10</sup>

# Certification of Laser Shock Peening For F-35C Ti-6Al-4V BA ELI Bulkheads

# Update of LSP on Ti-6Al-4V BA ELI

- Previous Presentations Provided Overview of Application of LSP to F-35C's Titanium Bulkhead Locations<sup>11-13</sup>
  - Three locations on bulkhead
  - Leveraged previously developed LSP settings for Ti-6Al-4V BA ELI
    - Reduced time for completion to 3 years instead of 6 for STOVL
    - Eliminated “Element” testing
    - Reduced number of bulkheads purchased due to reduced number of testing coupons required
  - Changed grip type to reduce number of lug failures
  - Applied ForceMate™ bushings to lug holes

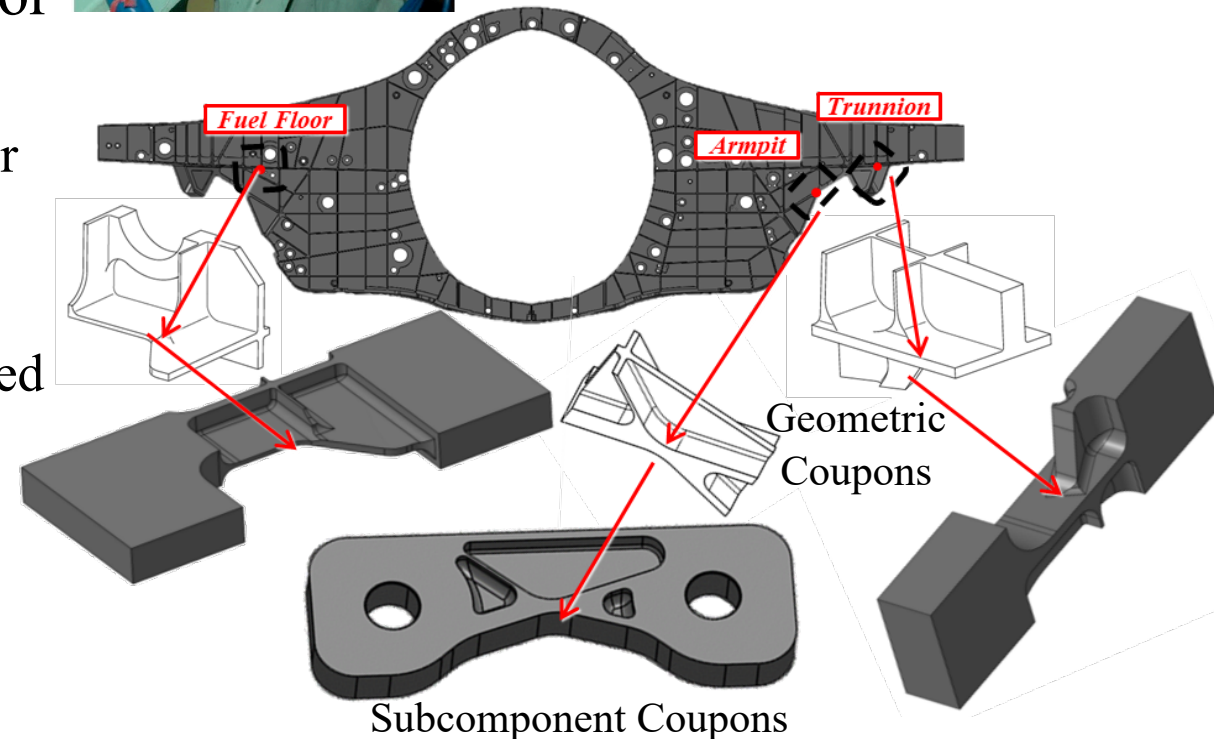
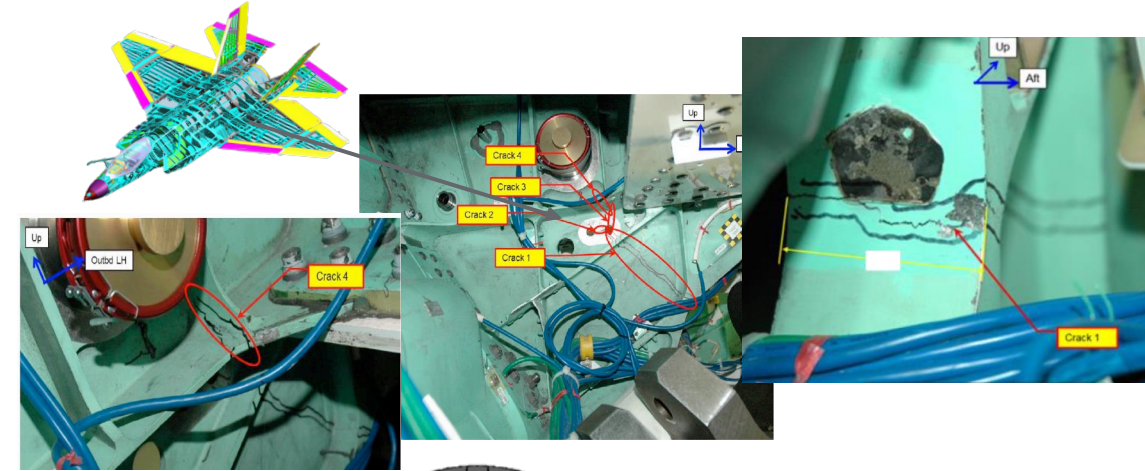

# Testing of the “Trunnion Runout”

- Subcomponent Testing Completed
  - 2 Baseline, No EDM notch tests
  - 1 Baseline, EDM notched test
  - 2 LSP, No EDM notch
  - 1 LSP, EDM notched
- Tested in a 110kip MTS Load Frame
- Time to a 0.01inch Crack was Based off of Time to First Marker Band Found
  - For Ti-6Al-4V BA ELI the grain size is greater than the 0.01inch requirement

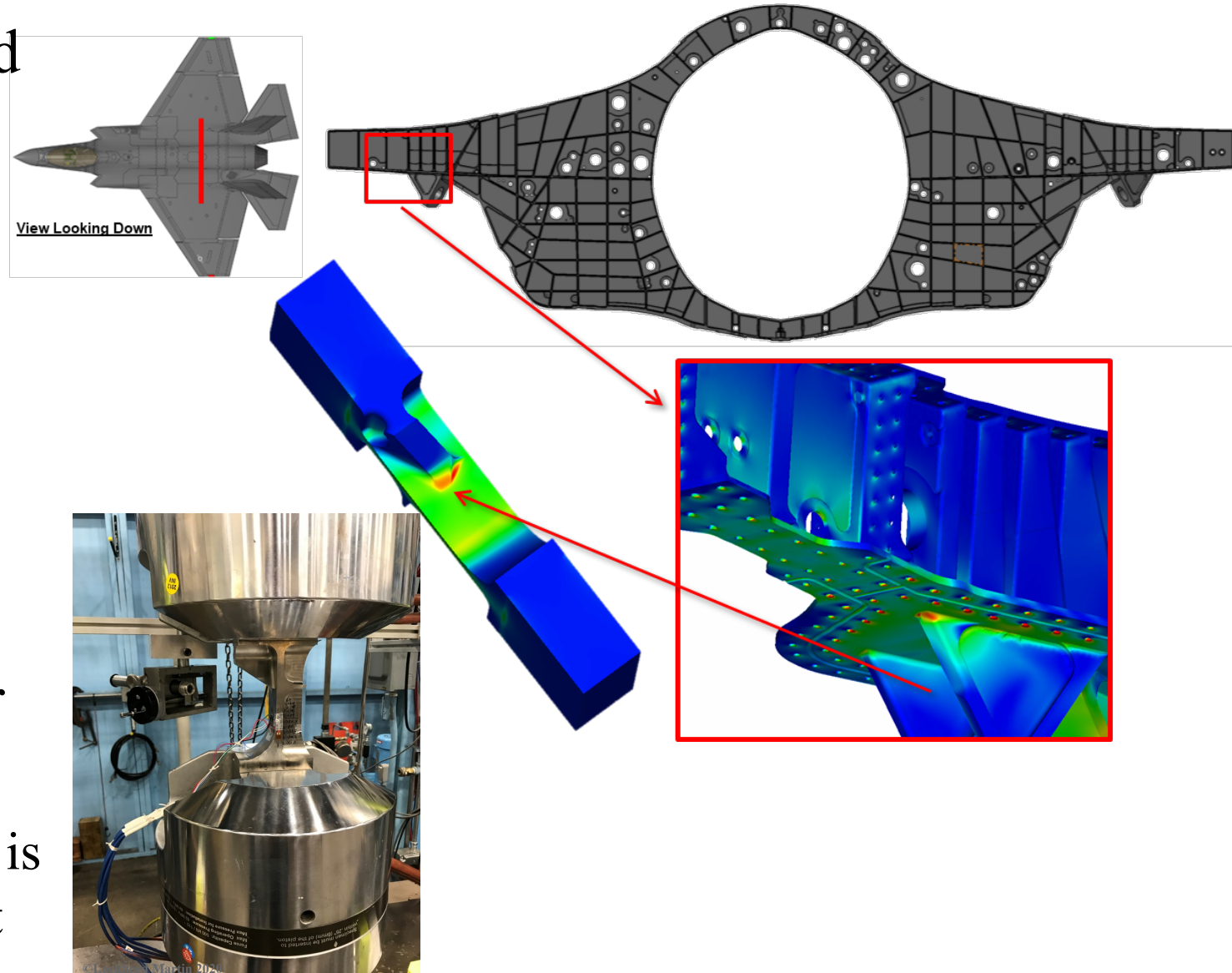

# Failure Location on Baseline Coupons

- All Baseline Subcomponents Failed in Gauge Area
  - Marker banding was able to find marker bands down to Avg. 0.055inch
  - Developing marker bands below approx. 0.03inch is very difficult in Ti-6Al-4V BA ELI<sup>14,15</sup>
- EDM Notched and Non-Notched Performed Very Repeatably
- Matched the FSDT Results for Fatigue and Crack Growth
- Great Confidence in Testing Execution

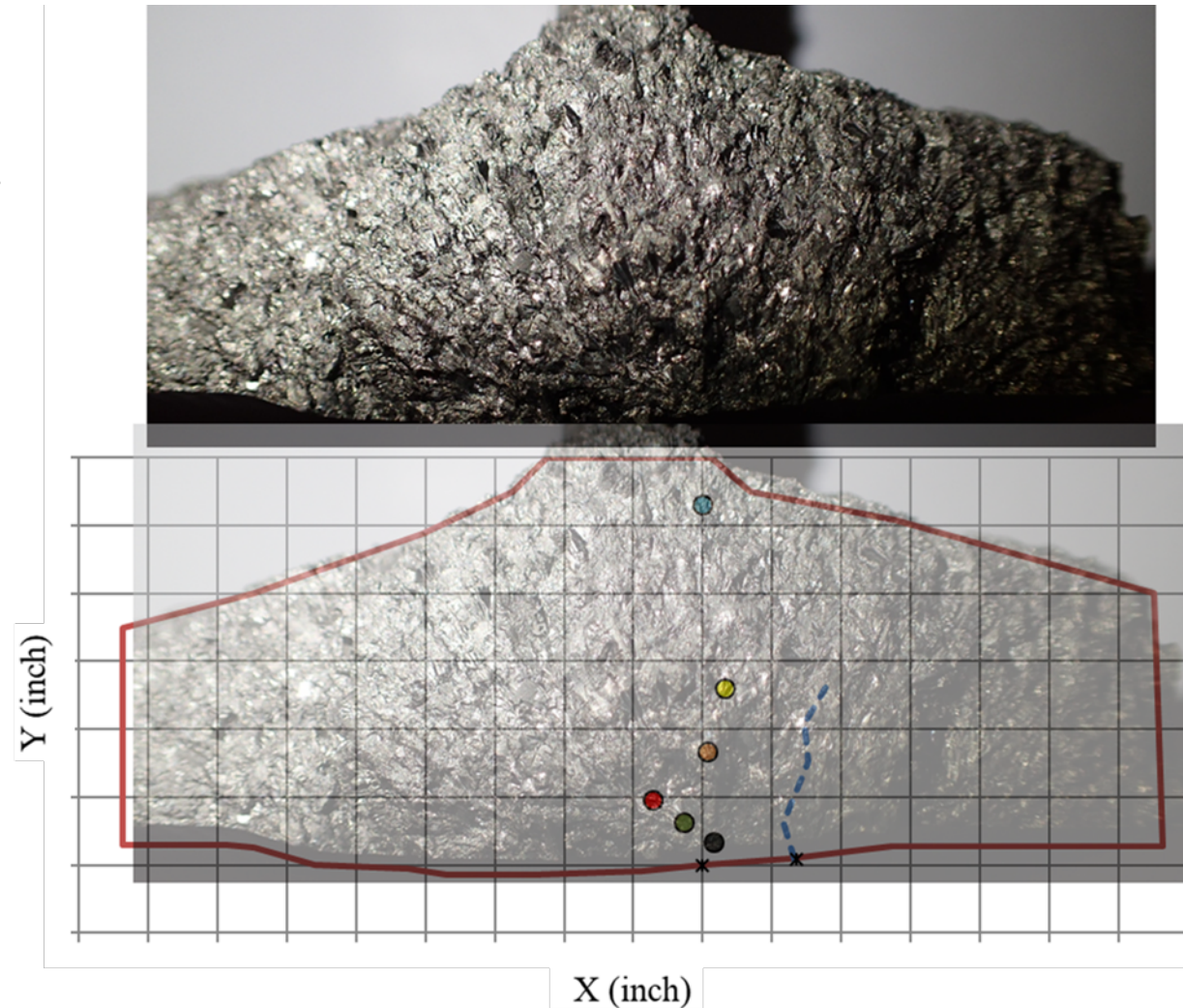

# LSPed Failure Location and Results

- All of the LSPed Subcomponents Failed Outside of the Test Gauge Area
- All Fatigue Tests (No EDM Notch) Went **Over 2x** the Requirement
- All Crack Growth Tests Went **3x** the Requirement
- At the End of All Tests No Cracks were Found in the Test Section
- Stress Gradient at Trunnion is **Steep & Shallow** – Perfect for LSP!

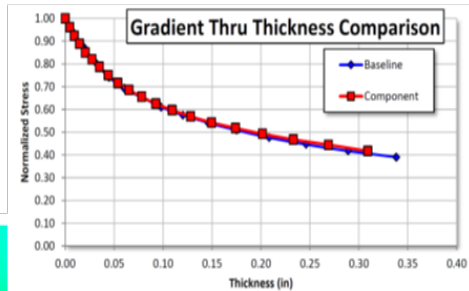
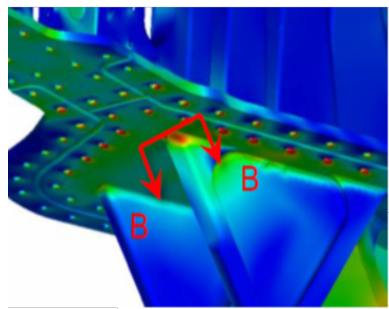

Subcomponent Cross-Section

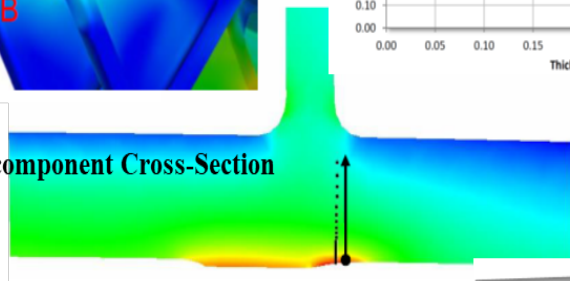

Local Stress from Applied Load

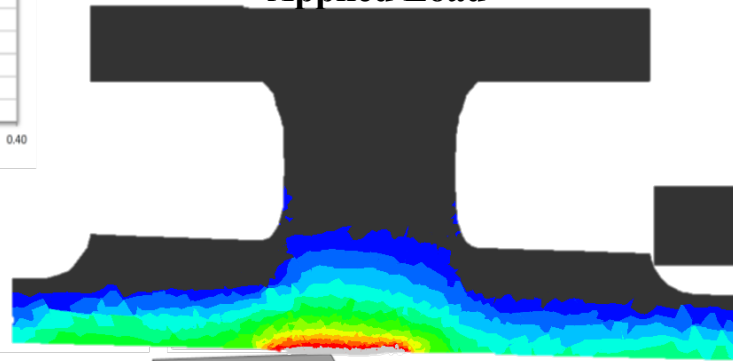

Combined Stress from Applied Load and LSP Residual Stress

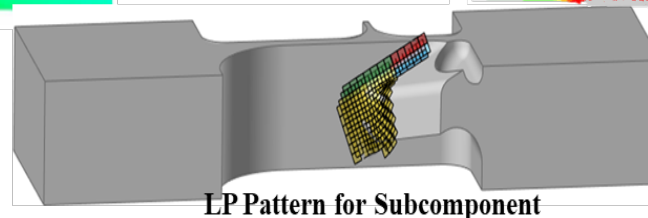
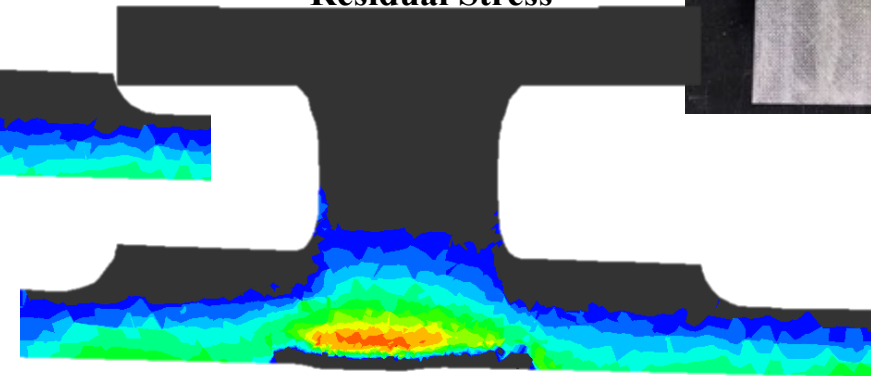

LP Pattern for Subcomponent



# Testing of the “Fuel Floor Flange”

- Location Cracked Thru Thickness and Propagated Down Flange in Durability Test
- Subcomponent Testing Included
  - 3 Baseline, No EDM notch tests
  - 1 Baseline, EDM notched test
  - 2 LSP, No EDM notch
  - 1 LSP, EDM notched
- Tested in a 110kip MTS Frame
  - 6inch wide grips used – bending was a factor
- All Tests Failed in the Test Section
- Baseline Test Lives Matched for Fatigue and Crack Growth
  - Avg. first marker band found at 0.0323inch

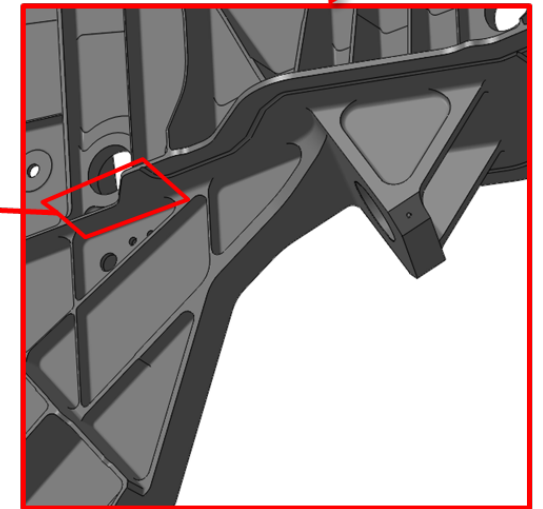
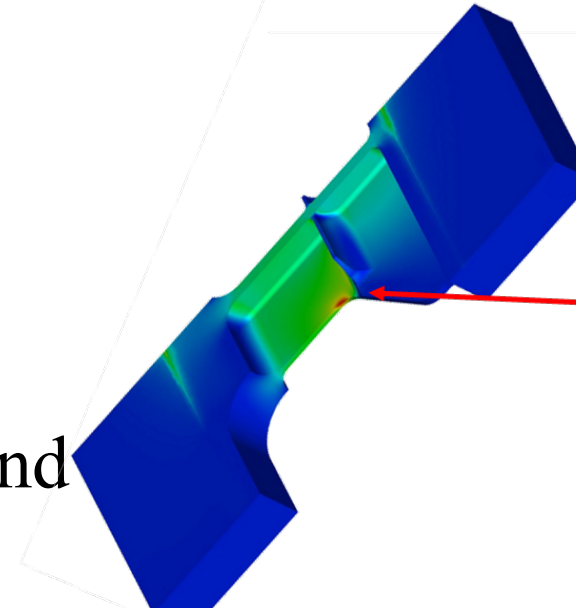
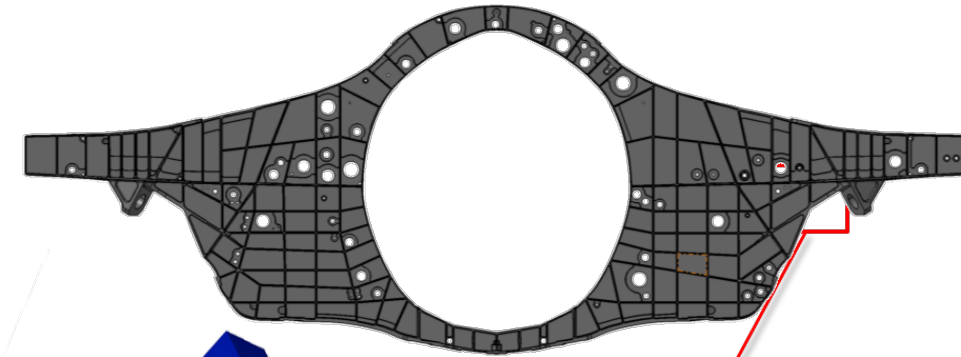
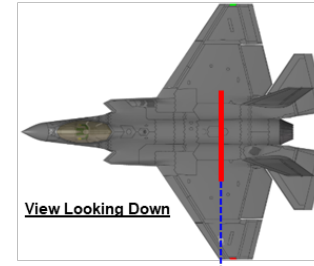

# Results of Fuel Floor Flange Testing

- All Subcomponents Failed at Critical Location
- All Subcomponent Tests Exceeded Requirement
  - Fatigue test – **2x** the life requirement
  - Crack Growth test – **2.5x** the life requirement
- Thinner Structure with Steep Shallow Stress Gradient

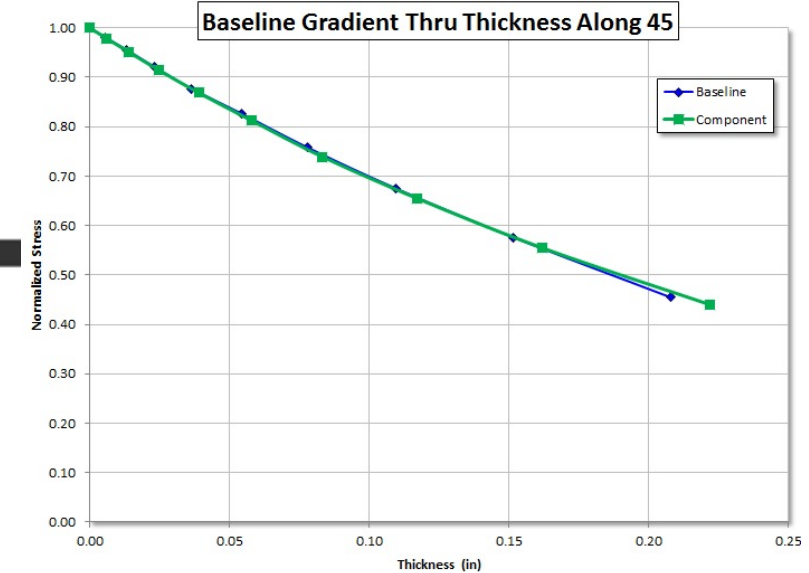
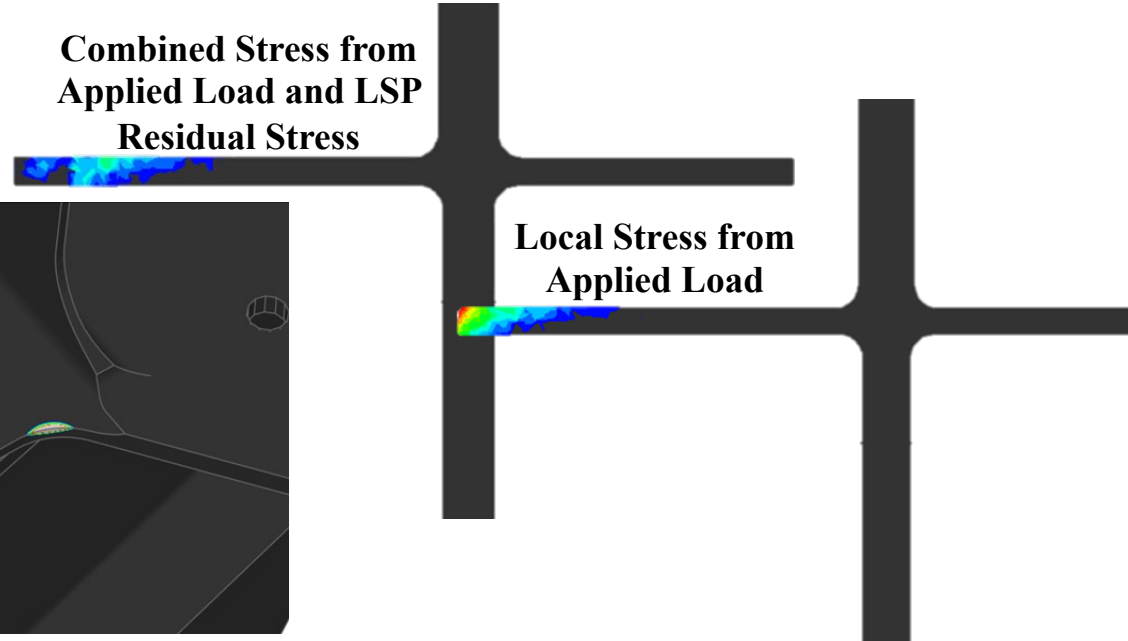
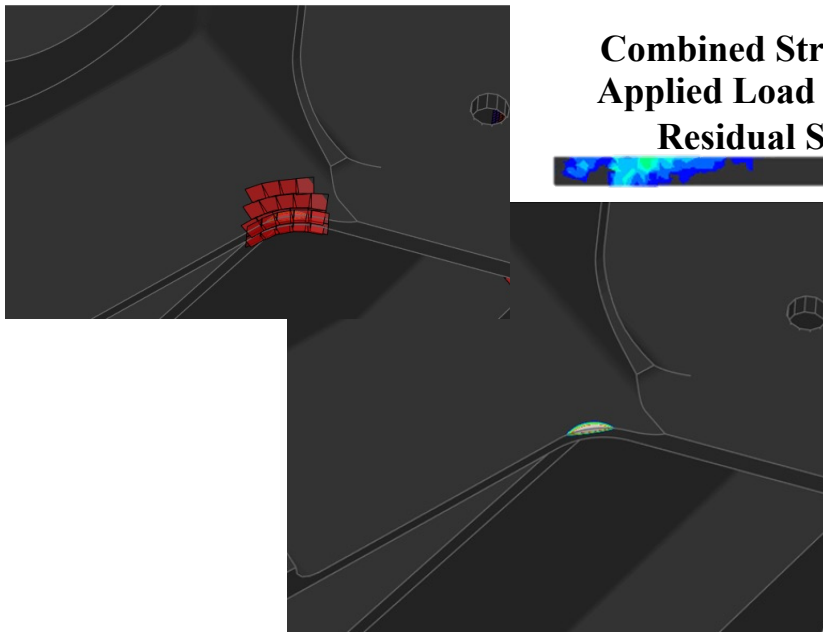
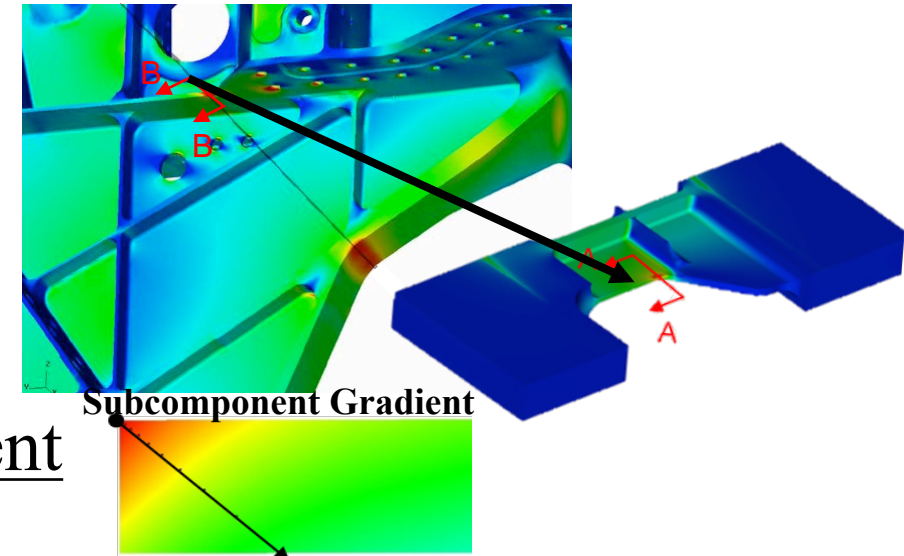

# Benefits of LSP on F-35C Bulkhead

- Three Locations were Found Cracked During the F-35C Full-Scale Durability Test
  - LSP was determined to be only way to repair location and enable full fatigue and crack growth life
- Crack Growth Results of Certification Testing of LSP on Trunnion Runout
  - Baseline crack growth tests lasted about half of life requirement
  - LSPed crack growth tests lasted **2.5X the life requirement** with no crack growth found past the edges of the EDM notch after a lifetime of test
- Crack Growth Results of Certification Testing of LSP on the Fuel Floor
  - Baseline crack growth test lasted half of life requirement
  - LSPed crack growth tests lasted **2.5X the life requirement** and had only 0.07inch of crack growth from EDM notch, and crack stopped growing after that, additional 1 lifetime of test
- LSP is a Great ERS Option for Structural Surface Features with Steep, Shallow Stress Gradients

# The “Armpit” – A Different Beast!

- Area Found Fully Cracked During Full-Scale Test
- Subcomponent Design Matched Stress Gradient, Peak Stress, and Stiffness
  - Stress gradient depth, width much different than other two locations
- Subcomponent Testing Included
  - 4 Baseline, No EDM notch tests
  - 1 Baseline, EDM notched test
  - 5 LSP, No EDM notch
- All Baseline Tests were Consistent with Results from FSDT for Fatigue and Crack Growth
- Tested in 220kip MTS Load Frame

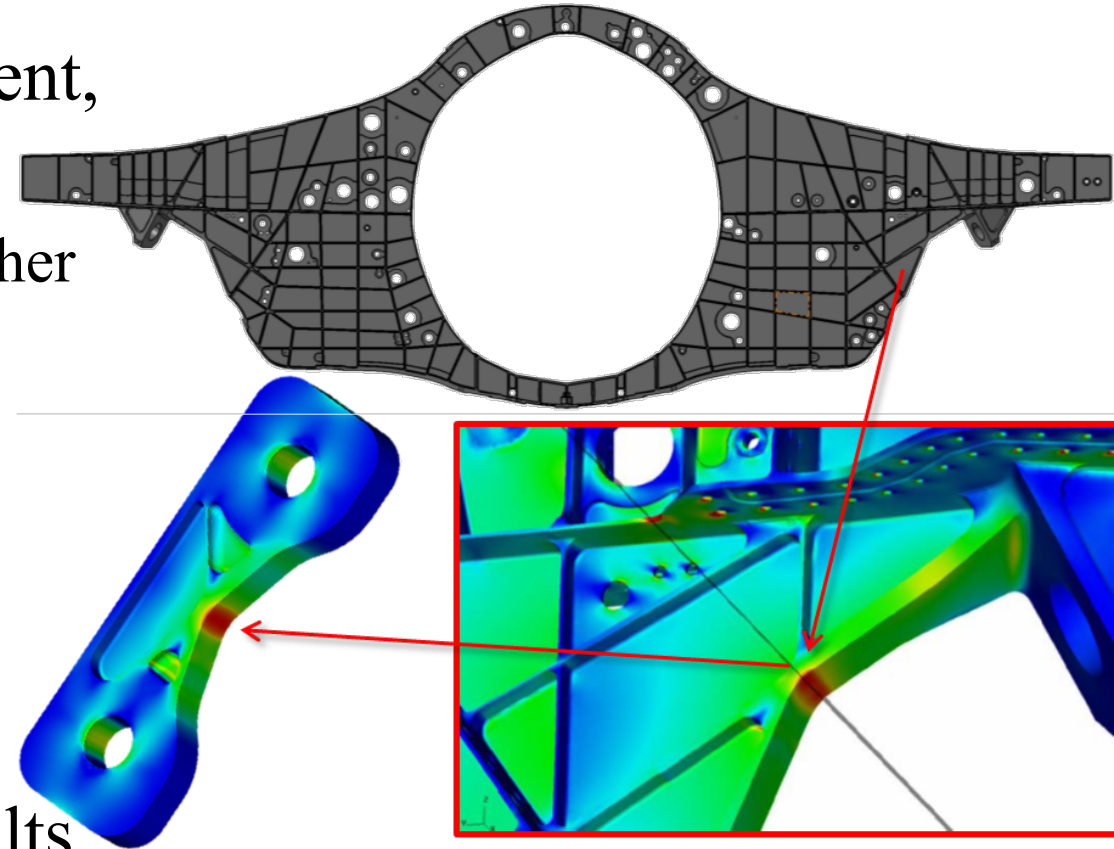

# Fatigue Test Results of LSP Coupons

- Performed 2 Tests with LSP “Wrapped” Around Critical Area
- Next Test Performed with Half the Number of Layers and Not “Wrapped” but “Horseshoed”
- 3<sup>rd</sup> LSP Configuration was a Middle Number of Layers
- **All LSP Fatigue Tests Nucleated and Failed from Subsurface Cracks**

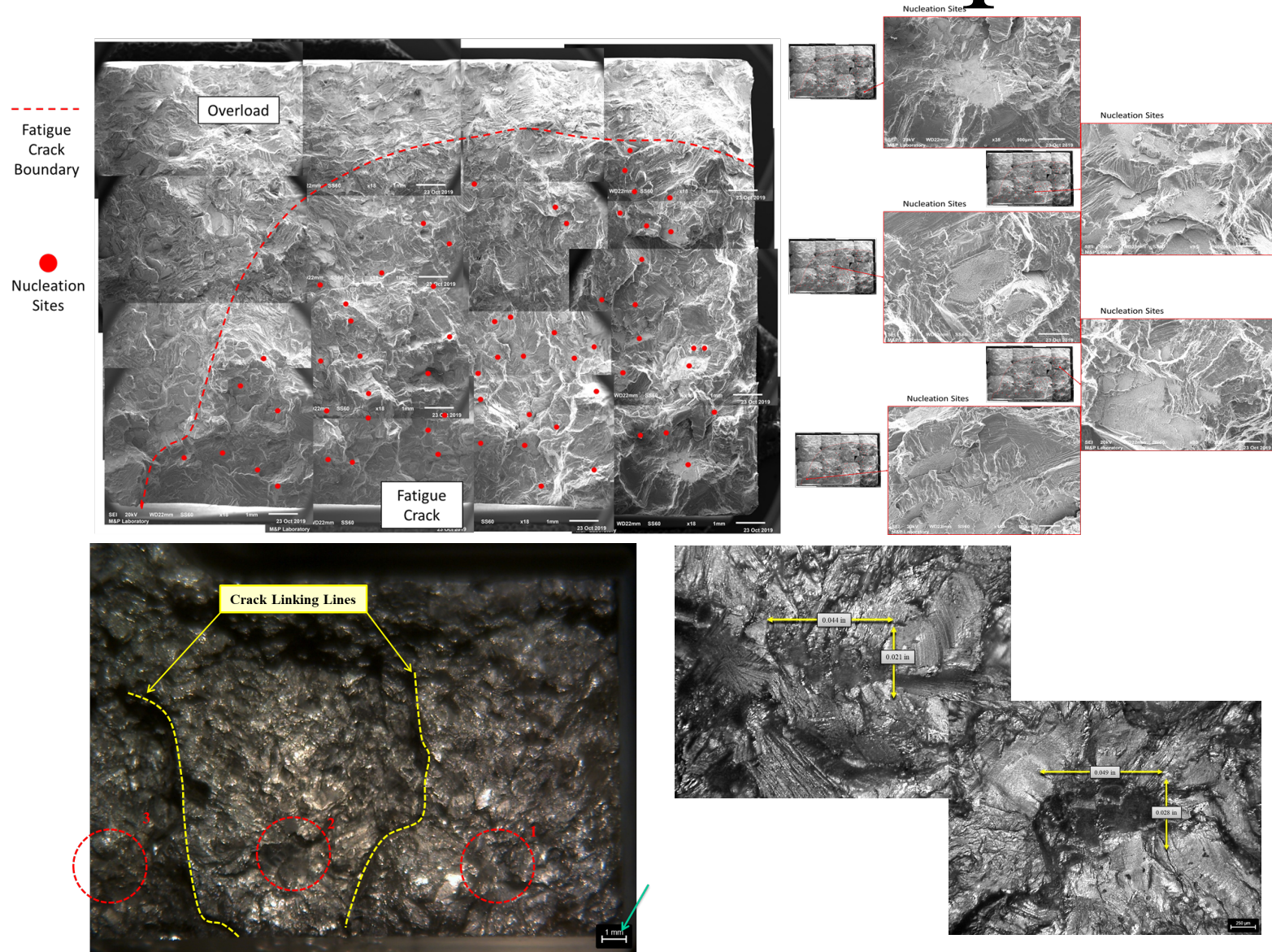

# Determining the Why and How

- Most Engineered Residual Stress Processes Perform Best With Shallow, Sharp Stress Gradients
  - Trunnion Runout and Fuel Floor Flange exhibit this stress feature
- Armpit Has Gradual, Deep, Stress Gradient
  - Almost like a pure tension test, but with a bit of bending
- All Introduced Compression Must be Balanced with Tension
  - Applied load and residual tension combined to a very high internal tensile stress region
  - Stress move towards the free surface
  - Potential cleaving of grains

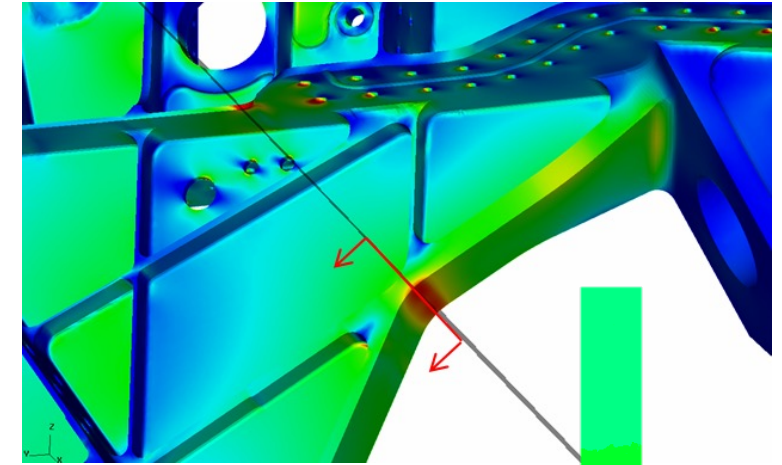

Cross-Section at Armpit with LSP Applied  
No Far-Field Load Applied

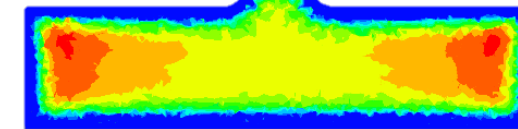

Far-Field + LSP Residual Stresses Applied

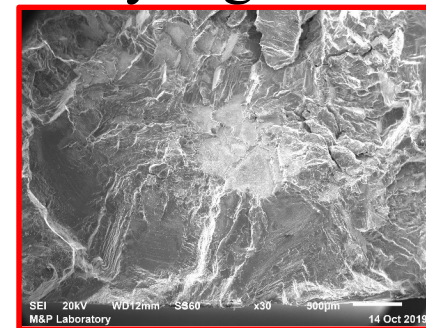
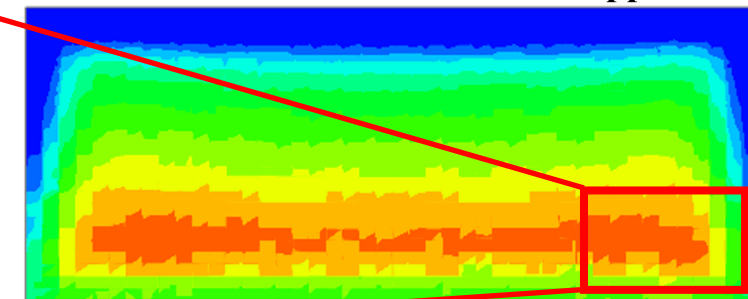

# Stress Gradient From Far-Field Load

- Comparison of FEA Simulation Stress Gradient Results Between All Locations
  - Scales are all the same
  - Far-field applied load shown
- Trunnion and Fuel Flange Have Material to Balance the Application of LSP
- Initial LSP Process for Armpit Introduced Surface Compression, BUT Pushed Tension Subsurface and NO Material to Balance Stresses

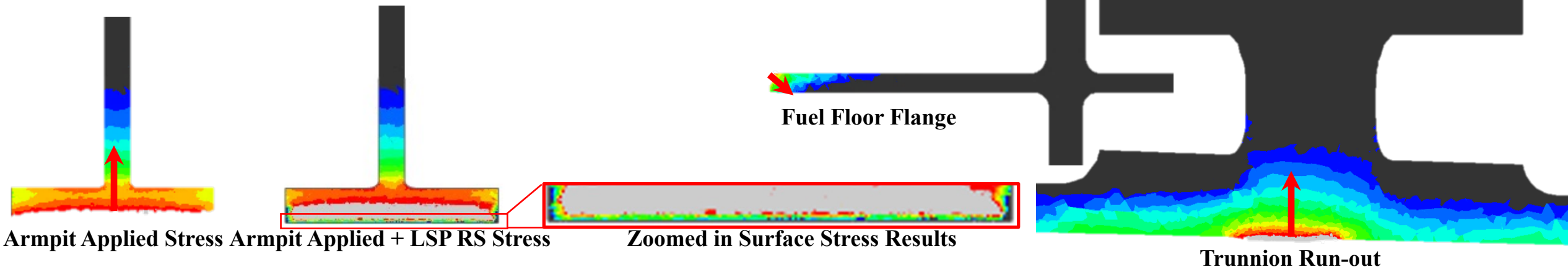
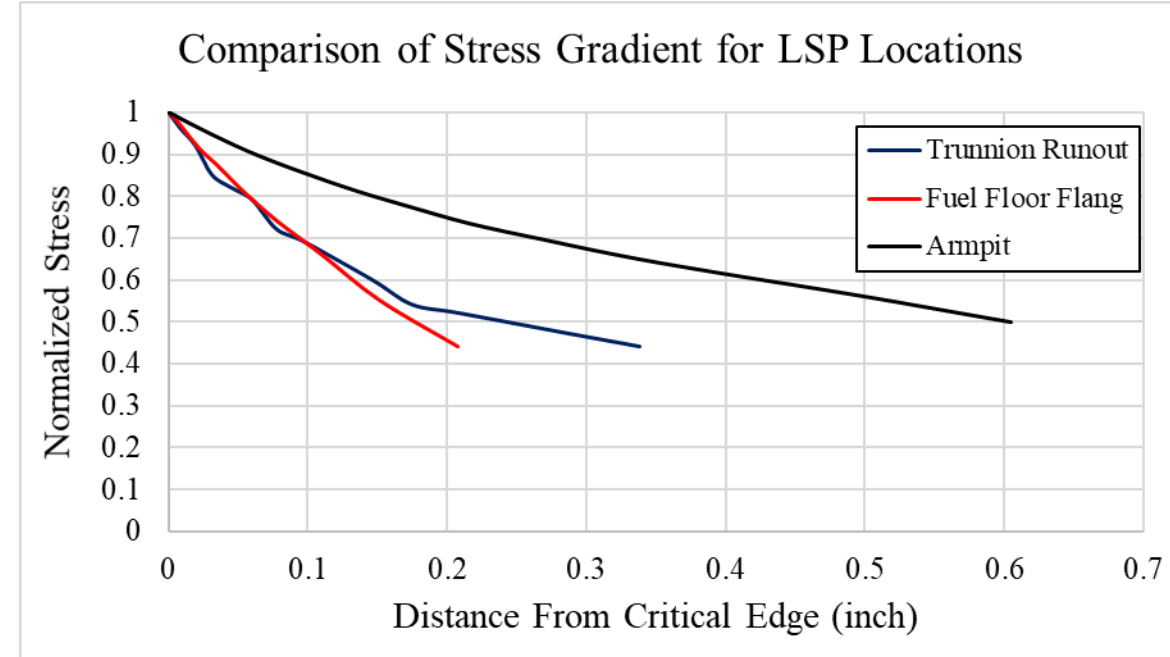

# Lessons Learned & Moving Forward

- Program Leveraged LSP Process Settings Used Previously on Ti-6Al-4V BA ELI
  - F-22 program performed robust, thorough test program for application
  - Application optimized for shallow stress gradient with material to allow for the subsurface tension field
  - Provided opportunity to compress validation testing schedule for application to F-35C
- Application at Armpit Has a **Very Gradual, Deep Stress Gradient**
  - Residual tension is always present and needs material to equilibrate it
- Application of LSP is not a “One-Size-Fits-All” Process
  - Developing new LSP process for deeper compressive penetration with lower levels of surface compression
  - Investigating outside-the-box irradiance, pulse width, and layers to enable this to occur – **pushing the state-of-the-art for a MUST HAVE solution**
- Future Testing Will Include Many Smaller Coupon Tests “Elements” and “Sub-elements”
  - Will allow for the testing and building of confidence in LSP process setting chosen for application on aircraft
- Application of ERS Continues to Require Validation Testing
  - Overcome “known-unknowns” and “unknown-unknowns”



# Acknowledgements

- Co-authors for this Presentation Include:
  - Mr. Pete Caruso – Retired Lockheed Martin
  - Mr. Wriley Gay – US Navy Structures and JPO Structural Lead
  - Mr. Jon Rankin – Curtis Wright Surface Technology/Metal Improvement Company Engineering Director
  - Mr. Vincent Sherman – Curtis Wright Surface Technology /Metal Improvement Company Process Engineer
  - Mr. Jody Sirmans – Lockheed Martin - F-35 Service Life Analysis Group Manager
  - Dr. Adrian DeWald – President of Hill Engineering, LLC.
  - Dr. Tom Mills – APES Inc., Principal Engineer
- This Program Has Many Hands that Lifted where they Stood – Thank you to you all!!
  - The Entire CWST/MIC Livermore Team – Lloyd Hackel, Brent Dane, Jim McManus, and others
  - JPO Sustainment and Mod Planning – Grover Murchison and Team
  - LM Sustainment and Mod Planning – Aubrey Bogard and Team
  - Fleet Readiness Center – East (Cherry Point, MCAS) – Engineering, Planning and Leadership
  - Naval Air Warfare Center, Weapons Survivability Lab (China Lake, NAS) – Chuck Frankenberger and Team
  - Many others

# References

1. Christian, M., (2010). “Overview of the Full-Scale Static and Durability Tests on F-35 Lightning II Program,” Proceedings of the 2010 Aircraft Structural Integrity Program (ASIP) Conference, San Antonio, TX, USA.
2. Dane, C.B., Hackel, L.A., Daly, J., Harrison, J., (1997). “Laser Peening of Metals – Enabling Laser Technology”, Report Number UCRL-JC-129029, Proceedings of the Materials Research Society 1997 Fall Conference, Boston, Ma, USA.
3. Abernethy, R.B., (2010). “The New Weibull Handbook, Fifth Edition”, Robert B. Abernethy, North Palm Beach, Fl, USA.
4. Clark, P.N., (2014). “Weibull Analysis of Fatigue Durability Data from Various Aircraft Pain Removal Techniques – Lessons Learned, Proceedings of the 2014 ASIP Conference, San Antonio, Tx, USA.
5. Bair, R., Garcia, W., Bunch, J., Weiss, R., (2009). “Application of Surface Residual Stresses for Durability and Damage Tolerance Improvements in F-22 Wing Attachment Lugs”, Proceedings of the 2009 ASIP Conference, Jacksonville, Fl, USA.
6. MacGillivray, K., Dane, B., Osborne, M., Bair, R., Garcia, W., (2010). “F-22 Laser Shock Peening Depot Transition and Risk Reduction”, Proceedings of the 2010 ASIP Conference, San Antonio, Tx, USA
7. Polin, L., Bunch, J., Caruso, P., McClure, J., (2011). “F-22 Program Full Scale Component Tests to Validate the Effects of Laser Shock Peening, Proceedings of the 2011 ASIP Conference, San Antonio, Tx, USA.
8. Babish, C., (2017). “Aircraft Structural Integrity Program (ASIP) Perspective on Accounting for Engineered Residual Stress in Damage Tolerance Analysis”, Proceedings of the 2017 ASIP Conference, Jacksonville, Fl, USA.
9. Babish, C., (2017). ““Aircraft Structural Integrity Program (ASIP) Perspective on Accounting for Engineered Residual Stress in Damage Tolerance Analysis”, Proceedings of the 2017 Residual Stress Summit, Dayton, Oh, USA.
10. Roper, W., (2020). “There is No Spoon: \_The New Digital Acquisition Reality”, Proceedings of the Air Force Association’s 2020 Virtual Air, Space and Cyber Conference, Virtual, USA.
11. Caruso, P., (2016). “Structural Certification of Laser Peening for F-35 Safety Critical Aluminum Forgings”, Proceedings of the 2016 ASIP Conference, San Antonio, Tx, USA.
12. Caruso, P., (2017). “Structural Certification of LSP for F-35 Safety Critical Aluminum Forgings”, Proceedings of the 2017 ASIP Conference, Jacksonville, Fl, USA.
13. Carlson, S., (2018). “Structural Certification of Laser Peening for F-35 Safety Critical Forgings”, Proceedings of the 2018 ASIP Conference, Phoenix, Az, USA.
14. Barter, S.A., Molent, L., Wanhill, R.J.H., (2009). “Marker Loads for Quantitative Fractography of Fatigue Cracks in Aerospace Alloys”, Proceedings of the 25<sup>th</sup> International Committee on Aeronautical Fatigue (ICAF), Rotterdam, The Netherlands.
15. McDonald, M., Boykett, R., Jones, M., (2012). “Quantitative Fractography Markers for Determining Fatigue Crack Growth Rates in Aluminum and Titanium Aircraft Structures”, Proceedings of the 28<sup>th</sup> International Conference of the Aeronautical Sciences, Brisbane, Australia.

***LOCKHEED MARTIN***

